

KENWOOD

sovereign

Users' Guide

How To Operate And Enjoy Your

VR-5700

VR-5090

VR-5080

Digital Audio/Video Receiver

Using Your New Kenwood Audio-Video Receiver

Welcome to the Users' Guide for your new Kenwood Audio-Video Receiver. It connects all your current audio and video components. It allows you to control them all with Kenwood's remarkable LCD remote.

This manual covers three models.

Table of Contents

Chapter One: Moving Around	1
What's on the Front Panel of Your Kenwood Audio - Video Receiver?	2
What's on Remote Control Unit?	4
LCD Indicators	6
How Do I Use Remote Control Unit?	7
Remote controllable range	7
Chapter Two: Controlling the Receiver	8
How Do I Adjust the Sound?	9
Turning the Speakers On	9
Adjusting the Volume	10
Adjusting the Tone (Only in STEREO mode with THX mode Off)	11
Adjusting the Loudness (Only in STEREO mode with THX mode Off)	13
Adjusting Speaker Levels	14
Adjusting the Input Level	15
Muting Sound	16
Midnight Theatre Function (Dolby Digital, DTS and DTS-ES only)	16

How Do I Adjust the Surround Modes?	17
What is the THX?	17
What are Listen Modes?	18
Checking the Input signal during playback	21
Input Modes	22
Switching Input Modes	23
To set the THX Mode	24
To set the Listen Mode manually	26
Examples of inputs with which switching is available	27
Description of Dolby Pro Logic II: Music mode	29
Selecting the parameter of Pro Logic II: Music mode	29
Applying Digital Signal Processor (DSP) Effects	31
HDCD and D.R.I.V.E. Effects	33
Headphone Operation	34
Selecting the Inputs	35
How Do I Operate Devices?	36
Playback of the device connected to the CD2/TAPE2 MONITOR	36
Operating a Television	37
Operating an AV Device	38
Operating a CD player	39
To play Kenwood 200-Disc CD Changer	39
Single or Rotary CD Player	41
CD-R Recorder	41
Operating an MD Recorder or Cassette Deck	42
Playing an Analog Turntable	43
Monitoring a Video Camera or Playing an Additional VCR ...	43

Radio Tuning	44
Recording	47
How Do I Adjust the LCD Display?	50
Using Remote Control unit under low light	50
Adjusting the contrast of LCD display	50
Adjusting the brightness of receiver	51
Selecting the display mode of receiver front panel	51
Executing Several Operations at Once (Macro function) ..	52
Registering a macro	52
Executing a macro	53
Using Remote Control Unit in Multiple Zones	54
How Do I Switch Control Modes?	54
Operation using the SYS.POWER button on Remote Control unit	56
Chapter Three : Button Layout in Controlling Other Devices	57
Chapter Four: Troubleshooting.....	69
Sound.....	71
I don't hear any sound at all	71
Audio is not output only when a 96k fs compatible disc is played.	71
The 96k fs indicator does not light while a 96k fs compatible disc is being played.	71

I can't hear sound from one or more of the speakers, or the sound is abnormally low	72
I can't hear sound from my surround or center speakers ...	72
I can hear sound only from the center speaker when Dolby Pro Logic is selected	72
A DTS-ES encoded source is played but it is not decoded in DTS-ES.	72
A Dolby Digital Surround EX-encoded source is played with THX Surround EX set to "Auto", but the source is not reproduced in 6.1-channel audio.	73
Sound from one (or more) of my components is abnormally loud or soft	73
I can't hear sound from some of my laser discs	73
There wasn't any sound recorded on tapes made on my VCR or tape deck	73
The initial sound is intermittent or non-existent when I start to play from a Dolby Digital, DTS, DTS-ES or MPEG source	73
With a Dolby Digital program or DTS program, the loud sounds aren't very loud and the quiet sounds aren't very quiet.....	74
All I hear is loud static when I play DTS discs	74
I hear a hum when I select the PHONO input	74
Sound is intermittent.....	74
I can't hear any sound in Zone B	74
Video	74
I can't see the program I'm playing on the TV. There wasn't any video output to my VCR when I recorded	74

Remote Control unit	75
My Remote Control unit is slow to respond—sometimes I have to press buttons or select commands several times	75
My Remote Control unit is not responding	75
I want to clear all the items in Remote Control unit and make it to the factory-set default condition.	76
The RF remote control function does not work	76
 Receiver/Tuner	 76
My receiver won't turn on and the STANDBY indicator is flashing	76
The sound is distorted, and the CLIP indicator on the receiver's front panel flashes red continually, or stays red for more than 1 second at a time	77
I can't receive a radio station	78
I'm getting a lot of static/interference	78
When I press a button to tune to a preset station, the receiver does not respond	78

Chapter One: Moving Around

Welcome to the Kenwood VR-5700/VR-5090/VR-5080 Users' Guide. This chapter explains the buttons and functions you can find on the front of the receiver and on Remote Control unit. The chapter also includes an explanation of how to navigate the convenient display on your new Remote Control unit.

It includes the following sections:

What's on the Front Panel of Your Kenwood Audio - Video Receiver?	page 2
What's on Remote Control Unit?	page 4
LCD indicators	page 6
How Do I Use Remote Control Unit?	page 7

What's on the Front Panel of Your Kenwood Audio-Video Receiver?

1. STANDBY indicator
2. I/⏻ POWER ON/STANDBY button
3. PHONES jack
4. SPEAKERS A/B button
5. INPUT MODE button / RF ON/OFF button
6. CD 2/TAPE 2 MONITOR button / RF BAND button
7. LISTEN MODE button /DISPLAY button
8. THX button
9. SOUND button / SET UP button
10. MULTI CONTROL (Up/Down) buttons
11. P. CALL (Up/Down) buttons
12. MEMORY button
13. AUTO button
14. BAND button
15. AV AUX input jacks

Standby mode

While the standby indicator of the unit is lit, a small amount of current is flowing into the unit's internal circuitry to back up the memory. This condition is referred to as the standby mode of the unit. While the unit is in the standby mode, it can be turned ON from the Remote Control unit.

What's on the Front Panel of Your Kenwood Audio-Video Receiver?, continued

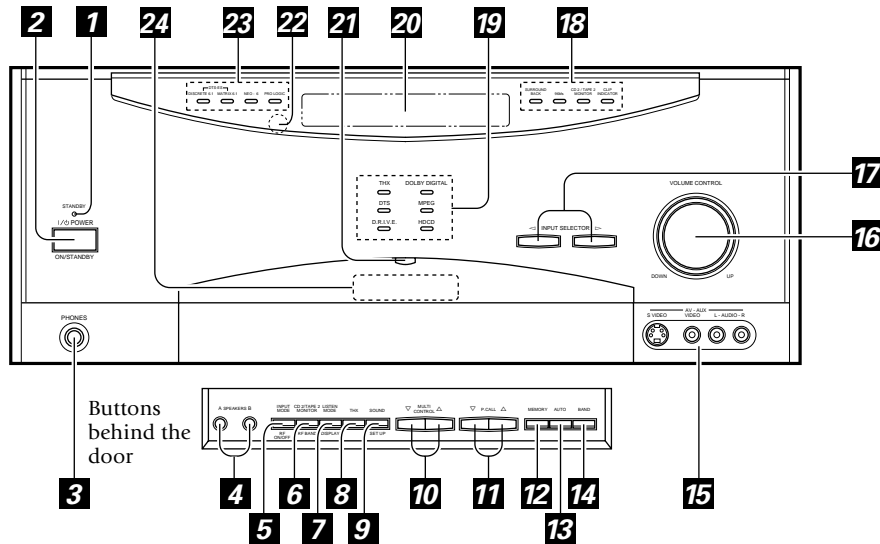

- 16.VOLUME CONTROL knob
- 17.INPUT SELECTOR buttons
- 18.Indicators
 - SURROUND BACK
 - 96kfs
 - CD2/TAPE2 MONITOR
 - CLIP INDICATOR

- 19.Indicators
 - THX
 - DTS
 - D. R. I. V. E.
 - DOLBY DIGITAL
 - MPEG
 - HDCD

- 20.Display
 - 21.2-way communication indicator
 - 22.Infrared remote sensor
 - 23.Indicators
 - DTS-ES DISCRETE 6.1
 - DTS-ES MATRIX 6.1
 - NEO : 6
 - PRO LOGIC
 - 24.Infrared remote transmitter

Button 4 to 14 are located inside the panel door.

What's on Remote Control Unit?

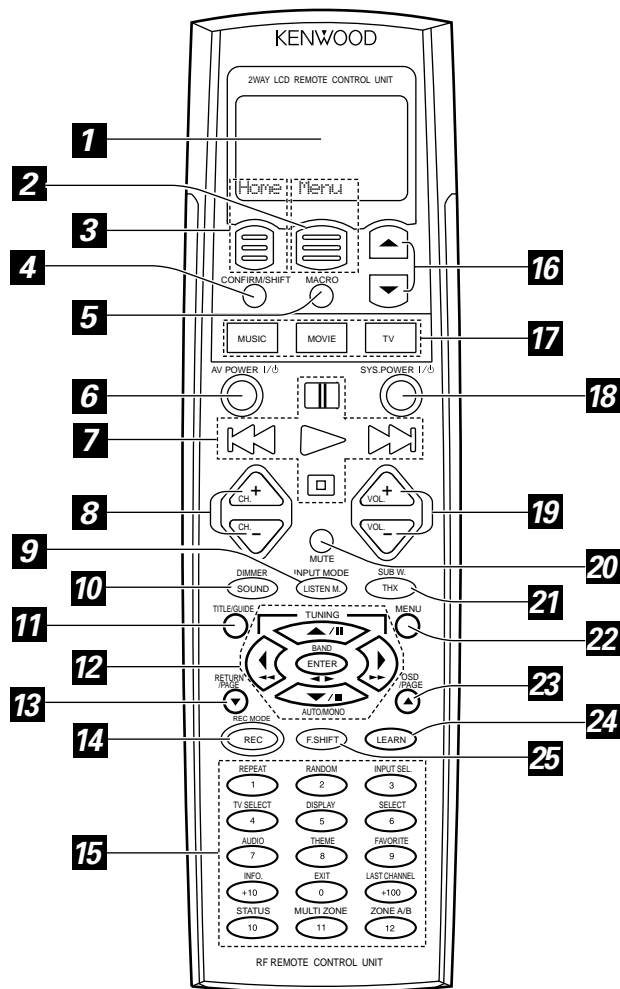

Infrared ray system
Model : RC-R0913

1. LCD indicators
2. LCD function button 2
3. LCD function button 1
4. CONFIRM/SHIFT button
5. MACRO button
6. AV POWER I/O button (AV device Power button)
7. AV device control buttons
 - ▶ : Play
 - ◀◀, ▶▶ : Skip
 - ⏸ : Pause
 - : Stop
8. CH. (+/-) buttons (AV device control buttons)
9. LISTEN M. button / INPUT MODE button
10. SOUND button / DIMMER button
11. TITLE/GUIDE button (AV device control button)
12. ▲Cursor up button / ⏸PAUSE button
 - ▼Cursor down button / AUTO/MONO, ■ STOP button
13. RETURN/PAGE ▼button (AV device control button)
14. REC (Recording) button / REC MODE button

What's on Remote Control Unit?

15. Numeric buttons (AV device control buttons)
 - 10 button / STATUS button
 - 11 button / MULTI ZONE button
 - 12 button / ZONE A/B button
16. LCD cursor up/down buttons
17. Input selector buttons
 - MUSIC: Audio device selector button
 - MOVIE: Video device selector button
 - TV: TV/video monitor selector button
18. SYS. POWER I/O (Receiver power) button
19. VOL. (+/-) buttons
20. MUTE button
21. THX button /SUB W. button
22. MENU button (AV device control buttons)
23. OSD/PAGE ▲ button (AV device control button)
24. LEARN button
25. F.SHIFT button

How to operate the F.SHIFT button:

In addition to the functions marked on the remote control buttons, those marked in blue characters above the buttons can be used. To use these functions, press the F.SHIFT button then press the desired button within 8 seconds.

(Example) To use the REPEAT function, press the F.SHIFT button then press button 1 (REPEAT).

LCD Indicators

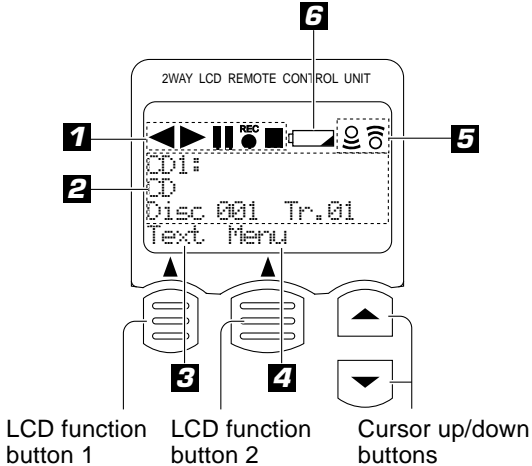

1. Playback/recording mode indicators

◀▶ Play indicator/ ||: Pause indicator/ ●^{REC}: Record indicator/
■: Stop indicator

2. Character display

Shows various information such as the input device name and track number.

3. Current function of LCD function button 1

4. Current function of LCD function button 2

5. Communication indicators

⊞: Sending. ⊞: Receiving.

6. Battery indicator

"" appears when the batteries are nearly exhausted. In this case, replace all of the four batteries together.

To switch the menu:



The menu can be switched over or selected while LCD function button 1 and/or 2 are displayed.

(Examples: Home, Back, Menu, Enter, etc.)

How Do I Use Remote Control Unit?

How Do I Use Remote Control Unit?

To select an item:

The displayed items can be scrolled or switched using the LCD cursor  or  button.

The selected item is displayed in the reversed color for distinction from other items.

Remote controllable range

Remote control unit can be controlled in the range as shown below using four AA (R6) batteries.

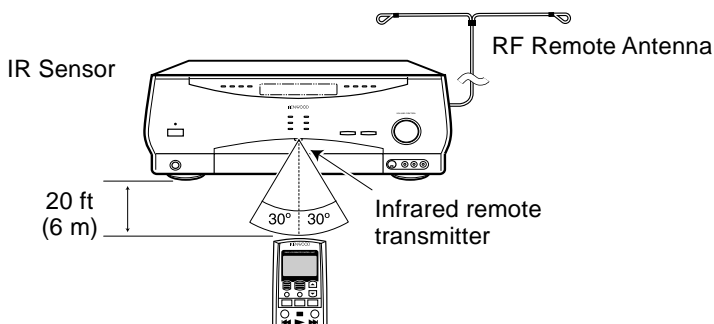

Take care of the following points when using Remote Control unit.

The remote control signal received by the main unit is the RF signal.

The signal sent from the main unit is sent as Infrared signal.

The control distance of the RF remote signal is about 30 ft (10 meters) provided there is no obstacle.

- Do not install the receiver in a place where the receiver's remote sensor is exposed to direct sunlight or high-frequency lighting (inverter type, etc.) fluorescent lamp. Otherwise the remote control range will be reduced.
- When the remote control range reduces or the Low Battery indicator () will flash in the LCD display, replace all of the four batteries together.

NOTES

The Remote Control unit transmits an infrared signal in addition to an RF signal. When operation by means of the RF signal is not possible because of the radio wave conditions, aim the Remote Control unit towards the receiver and use it as an infrared remote control.

For operation of other identified devices or with an external IR receiver, aim the Remote Control unit towards the respective unit and use it as an infrared remote control.

Do not block the remote control IR transmitter on the Receiver or the transceiver part of the Remote Control unit. A momentary error is possible when the signal is interrupted even momentarily during transmission and reception (for example by a person passing through the beam).

In such a case, the most recent information will be displayed when **CONFIRM/SHIFT** button on the Remote Control unit is pressed. Sometime it may be necessary to reenter the interrupted command again.

Chapter Two: Controlling the Receiver

Remote Control unit provided with the receiver is a bi-directional Remote Control unit, which enables remote control while checking the information shown on the LCD display. The operations of connected devices can also be controlled from Remote Control unit.

Before first time using the receiver or after having changed or added the connected devices, please be sure to read the separate booklet entitled "*Connection and Setup Guide*".

The present manual describes the operation procedures in normal use.

This chapter is composed of the following sections.

How Do I Adjust the Sound?	page 9
How Do I Adjust the Surround Modes?	page 17
Selecting the Inputs	page 35
How Do I Operate Devices?	page 36
How Do I Adjust the LCD Display?	page 50
Executing Several Operations at Once (Macro function)	page 52

How Do I Adjust the Sound?

You can control and adjust a variety of sound settings using the receiver's front panel or Remote Control unit.

Turning the Speakers On

To turn on the front A speakers, open the receiver's front panel door and press the **SPEAKERS A** button.

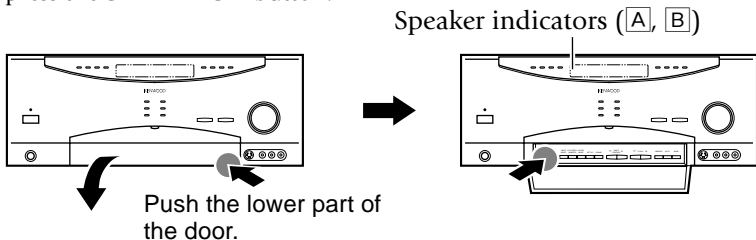

To turn on the front B speakers, press the **SPEAKERS B** button located in the door of the receiver's front panel.

The lighting of a **A** or **B** indicator lamp indicates that the corresponding set of speakers is on.

If you select **SPEAKERS B** while listening to a surround mode, the sound will automatically revert to stereo. While **SPEAKERS B** is on, the surround mode cannot be selected.

If you use speakers connected to amplifiers via the **PRE OUT** jacks, choose **SPEAKERS A**.

How Do I Adjust the Sound?

Adjusting the Volume

Use one of the following methods to adjust the volume.

- Turn the **VOLUME** knob on the front panel of the receiver.

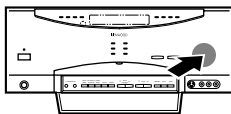

- Press  or  on Remote Control unit.





Adjusting the Tone (Only in STEREO mode with THX mode Off)

The Tone control adjusts the bass and treble tone of your front speakers manually. In addition to setting Bass and Treble tone adjustment values, you can completely bypass the tone control circuitry for a purer sound.

1. Press the **SOUND** button on Remote Control unit repeatedly until **Tone = Off** or **On** is displayed.

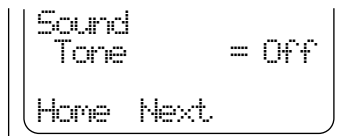



On or **Off** refers to the current setting status.

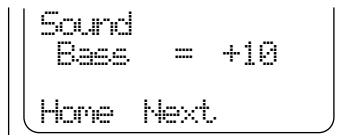

2. Press the LCD cursor up/down (/) button on Remote Control unit to select **Tone = On** (or **Off** if desired so).
3. When **On** is selected above and the **SOUND** button or **Next** button is pressed again, the **Bass** setting menu appears.

When **Off** is selected above, the **Loudness** setting menu appears.



4. Press the LCD cursor up/down (/) button on Remote Control unit to select the desired tone level.
Adjust in the range from +10 to -10.
5. Press the **Next** button (LCD function button 2).
6. The **Treble** setting menu appears.
7. Press the LCD cursor up/down (/) button on Remote Control unit to select the desired tone level.
Adjust in the range from +10 to -10.
8. To exit from setting, press the **Home** button (LCD function button 1).

Operation on the receiver:

1. Press the **SOUND** button in the door repeatedly until **TONE OFF** or **ON** is displayed.
2. Press the **MULTI CONTROL** (Δ/∇) button to display **TONE ON** (or **OFF** if desired so).
3. When **ON** is selected above and the **SOUND** button is pressed again, the **BASS** setting menu appears.
When **OFF** is selected above, the **LOUDNESS** setting menu appears.
4. Adjust using the **MULTI CONTROL** (Δ/∇) button.
5. Press the **SOUND** button.
6. When the **TREBLE** setting menu appears, adjust the treble in the same way as above. To exit from setting, press the **SOUND** button repeatedly until "**SOUND FIXED**" is displayed.



Adjusting the Loudness (Only in STEREO mode with THX mode Off)

The Loudness control increases the bass and treble at low volume control settings. This adjusts to the way the human ear hears sound at quiet volumes, retaining music's fullness and sparkle.

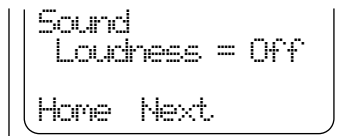

1. Press the **SOUND** button on Remote Control unit repeatedly until **Loudness = Off** or **On** is displayed.

On or **Off** refers to the current setting status.



2. Press the LCD cursor up/down (/) button on Remote Control unit to select **Loudness = On** (or **Off** if desired so), then press the **Home** button (LCD function button 1).

Operation on the receiver:

1. Press the **SOUND** button inside the door repeatedly until **LOUDNESS OFF** or **ON** is displayed.
2. Press the **MULTI CONTROL** (/) button to select **LOUDNESS ON** (or **OFF**), then press the **SOUND** button repeatedly until "**SOUND FIXED**" is displayed.

Adjusting Speaker Levels

You can use the Sound menu to temporarily adjust the speaker levels of your center speaker, surround speakers, surround back speakers and subwoofer. For example, if a particular movie has dialog that's hard to understand, you can temporarily increase the center channel volume just for that movie. For more information on adjusting speaker levels permanently, see "Chapter Two: Setting Up Remote Control Unit" in the *Connections and Setup Guide*.

1. Press the **SOUND** button on Remote Control unit repeatedly until the speaker name to be adjusted is displayed.

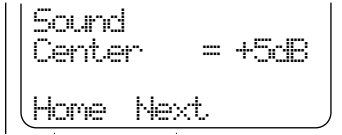

Center : center speaker

Sur. Right :] left and right surround speakers
Sur. Left :]

Sur. Back R :] left and right surround back speakers
Sur. Back L :]

Sub Woofer : subwoofer

The two surround speakers cannot be adjusted independently between each other.

The two surround back speakers cannot be adjusted independently between each other.

2. Press the LCD cursor up/down (▲/▼) button on Remote Control unit to select the desired volume level, then press the **Home** button.

Operation on the receiver:

1. Press the **SOUND** button inside the door repeatedly until the name of the speaker(s) to be adjusted is displayed.

C : center speaker

SL/SR : left and right surround speakers

SBL/SBR : left and right surround back speakers

SW : subwoofer

How Do I Adjust the Sound?

2. Press the **MULTI CONTROL** (Δ/∇) button to select the desired volume level, then press the **SOUND** button repeatedly until "**SOUND FIXED**" is displayed.

If you select another source device or turn off the receiver, the above setting is reset to the level adjusted in Chapter Two of the *Connection and Setup Guide*.

Adjusting the Input Level

If the front panel **CLIP** indicator will flash red continually, lower the analog input level for the source device you're listening to. (Setting the proper input level eliminates distortion that occurs if a source device's output level is too high. Occasional brief flashing of the CLIP indicator is okay).

1. Select the input to be adjusted (see "Selecting the Inputs" on page 35).
2. Press the **SOUND** button on the Remote Control unit until **Analog Level** is displayed.

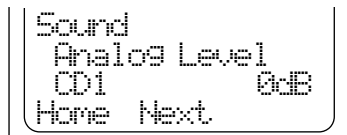

3. Press the LCD cursor up/down (\uparrow/\downarrow) button on Remote Control unit to select the desired input level, then press the **Home** button.
Select one of the three input levels; 0 dB, -3 dB and -6 dB. (The dB is the unit expressing the amplitude of sound.)

Operation on the receiver:

1. Press the **SOUND** button inside the door repeatedly until **ANLG INPUT** is displayed.
2. Press the **MULTI CONTROL** (Δ/∇) button to select the desired input level, then press the **SOUND** button repeatedly until "**SOUND FIXED**" is displayed.

How Do I Adjust the Sound?

Muting Sound

The sound can be muted temporarily.

- Press the **MUTE** button on Remote Control unit. The **MUTE** indicator on the receiver panel blinks during muting.

Use one of the following methods to cancel muting.

- Adjust the Volume control on either the receiver or Remote Control unit.
- Press the **MUTE** button again.

The **MUTE** indicator on the receiver panel goes off.

Midnight Theater Function (Dolby Digital, DTS and DTS-ES only)

Any time you don't want to experience the loud and soft volume extremes of recorded sound (for example, late at night), use midnight theatre function to reduce volume extremes. This feature keeps loud, dramatic sound from being too loud (perhaps disturbing family members or neighbors) while ensuring that you can still hear whispered dialog or other soft sounds.

Midnight theater function only works if you are listening to a Dolby Digital program or DTS (DTS-ES) that has been encoded with special compression data.

To use the Midnight Theater function:

1. Press the **SOUND** button on the Remote Control unit repeatedly until **Midnight 1, 2** or **Off** is displayed.

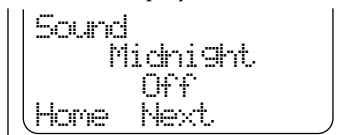

2. Press the LCD cursor up/down (\uparrow/\downarrow) button on Remote Control unit to select **Off, 1** or **2**, then press the **Home** button.
 - OFF for normal balancing
 - 1 for quieter balancing
 - 2 for quietest balancing (the least difference between the loudest and quietest sound)

Operation on the receiver:

1. Press the **SOUND** button inside the door repeatedly until **MIDNIGHT 1, 2** or **OFF** is displayed.
2. Press the **MULTI CONTROL** (Δ/∇) button to select **OFF, 1** or **2**, then press the **SOUND** button repeatedly until "**SOUND FIXED**" is displayed.

How Do I Adjust the Surround Modes?

You can experience true home-theater sound with your Kenwood Audio-Video Receiver. This receiver incorporates several listen modes to let you enjoy surround sound with a wide variety of program sources. Each produces multiple channels of surround-sound, but each does it differently.

What is the THX?

- **THX:** Movie soundtracks are mixed in special movie theaters called dubbing stages and are designed to be played back in movie theaters with similar equipment and conditions. The soundtrack created for movie theaters is then transferred directly onto Laserdisc, VHS tape, DVD, etc., and is not changed for playback in a small home theater environment.

THX engineers developed patented technologies to accurately translate the sound from the movie theater environment into the home, correcting the tonal and spatial errors that occur. On the VR-5700/VR-5090/VR-5080, when the THX mode is on, the THX technologies are automatically added after the decoded signal.

Movies which have been encoded in Dolby Digital, DTS, MPEG, Dolby Pro Logic, Stereo and Mono can all benefit from activating the THX technologies. THX should be activated only when watching movies which were mixed for playback in large movie theater environments. THX need not be activated for music, movies that were made especially for television or shows such as sports programming, talk shows, etc. This is because they were mixed in a small room environment.

- **THX Surround EX:** THX Surround EX - Dolby Digital Surround EX is a joint development of Dolby Laboratories and the THX division of Lucasfilm Ltd.

In a movie theater, film soundtracks that have been encoded with Dolby Digital Surround EX technology are able to reproduce an extra channel which has been added during the mixing of the program. This channel, called Surround Back, places sounds behind the listener in addition to the currently available front left, front center, front right, surround right, surround left and subwoofer channels. This additional channel provides the opportunity for more detailed imaging behind the listener and brings more depth, spacious ambience and sound localization than ever before.

How Do I Adjust the Surround Modes?

Movies that were created using the Dolby Digital Surround EX technology, when released into the home consumer market may exhibit a Dolby Digital Surround EX logo on the packaging. A list of movies created using this technology can be found on the Dolby web site at <http://www.dolby.com>.

Only receiver and controller products bearing the THX Surround EX logo, when in the THX Surround EX mode, faithfully reproduce this new technology in the home.

This product may also engage the "THX Surround EX" mode during the playback of 5.1 channel material that is not Dolby Digital Surround EX encoded. In such case the information delivered to the Surround Back channel will be program dependent and may or may not be very pleasing depending on the particular soundtrack and the tastes of the individual listener.

What are Listen Modes?

- **Dolby Digital:** Dolby Digital uses an encode/decode process based on its theatrical digital surround sound technology. The five main channels are full-frequency and independent, so sound can completely envelop you or soar anywhere in the room, just like at the movies.

Compared with Dolby Pro Logic, Dolby Digital has more clarity, greater surround envelopment, and more realistic sound movement between channels.

Although a full set of speakers (front left and right, center, surround left and right, and a subwoofer) is required for true Dolby Digital surround sound, this receiver lets you enjoy Dolby Digital program sources, even if you connect fewer speakers.

- **Dolby Pro Logic/Dolby Pro Logic II:** Dolby Pro Logic reproduces a surround sound like in a movie theater from Dolby Surround-encoded program source (videotape or LaserDisc software carrying the Dolby Surround logo), and features excellent sound movement on the front and a surrounding atmosphere of movie theaters. Meanwhile, Dolby Pro Logic II decodes a signal encoded in 2 channels into 5-channel signals composed of the left/right front signals, center signal and surround left/right signals. If no surround speaker is Setup, the surround signal is sent to front left and right speakers. (Dolby 3 stereo)

Dolby Pro Logic II is an advanced version of the decoding technology used with Dolby Pro Logic. It inputs 2-channel signals from a Dolby

How Do I Adjust the Surround Modes?

Surround-encoded source and reproduces 5-channel signals in which the surround channel is divided into independent channels for the left and right. Dolby Pro Logic II has the MOVIE mode and MUSIC mode, and the MUSIC mode enables independent adjustment of three parameters including Panorama mode, Dimension and Center Width. See page 29 for the Dolby Pro Logic II parameters.

To allow the users enjoy multichannel playback also from the analog audio of currently available Dolby Surround home video software, the VR-5700/VR-5090/VR-5080 incorporates a Dolby Pro Logic II surround decoder.

Manufactured under license from Dolby Laboratories. "Dolby", "Pro Logic", "Surround EX" and the double-D symbol are trademarks of Dolby Laboratories.

- **DTS** : DTS has five full-frequency channels that create effects nearly identical to those in a theater. Sounds seem to zoom from one place to another or entirely surround you. Like Dolby Digital, DTS has much-improved clarity, surround and sound movement capability compared with Dolby Pro Logic. This listen mode is available on CD, LD, and DVD media. DTS is a strictly digital format that can be supplied only by a CD, LD, or DVD player that supports DTS sound. If you attempt to listen to DTS encoded media through the analog connections to your new receiver, you will experience digital noise (loud static).
- **DTS-ES Discrete 6.1, DTS-ES Matrix 6.1**: Both DTS-ES Discrete 6.1 and DTS-ES Matrix 6.1 add the surround back channel audio to the DTS 5.1-channel format to improve the acoustic positioning and makes acoustic image movement more natural with the 6.1-channel reproduction. This receiver incorporates a DTS-ES decoder, which can handle DTS-ES Discrete-encoded and DTS-ES Matrix-encoded program sources from DVD, etc.

DTS-ES Discrete 6.1 features digital discrete recording of all channels including the surround back channels and higher quality of audio reproduction.

DTS-ES Matrix 6.1 features matrix encoding of surround back (SB) signals in the SL/SR signals and decoding of the matrix into the SL, SR and SB signals during playback.

How Do I Adjust the Surround Modes?

- **DTS NEO:6:** This is a new technology which decodes 2-channel signals into 6-channel signals using high-accuracy digital matrix technology. The DTS NEO:6 decoder has near-discrete properties in the frequency characteristics of the channels as well as in channel separation. According to the signals to be played back, DTS NEO:6 uses either the NEO:CINEMA mode optimized for movie playback or the NEO:MUSIC mode optimized for music playback.
- **MPEG:** MPEG, which stands for “Moving Pictures Experts Group”, is an international standard of digital video and audio compression and decompression in media. It is the most efficient encoding method for compressed multi-channel audio which provides the highest sound quality to deliver the best movie theater sound into the home.
- **DSP (Digital Signal Processing):** DSP allows you to create your own custom surround sound environments and use them with any source (except Dolby Digital, MPEG, DTS and DTS-ES). You can select the ambience of an Arena, Jazz Club, Stadium, Cathedral, Theater or Concert hall, and then modify the parameters to ‘fine-tune’ the environment to your taste. (See “Applying Digital Signal Processor (DSP) Effects” on page 31 for details about making DSP adjustments.)
- **Multi ch Music (Multichannel music):** All speakers are used to realize a stereo sound with a wide listening range.
- **Stereo:** Stereo listen mode provides standard stereo sound to the front left and right speakers.

NOTES

- You cannot select the Input Analog mode if you are playing DTS-encoded media.
- You cannot listen to DTS-encoded media in Zone B.
- When playing DTS-encoded media, wait until “DTS” appears on the receiver display before proceeding.
- The listen mode is fixed to Stereo during playback of 96k fs signals.

How Do I Adjust the Surround Modes?

Checking the Input signal during playback

During playback of Dolby Digital, MPEG or DTS signal, the surround identification signal in the input is identified and displayed by means of the L, C, R, SR, SB (or S), SL and LFE icons.

1. Press the **F.SHIFT → 10 (STATUS)*** button on Remote Control unit.

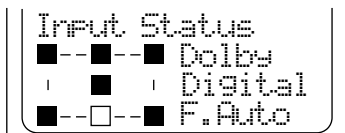
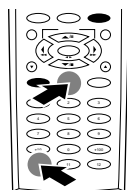

After 8 seconds, the display goes off.

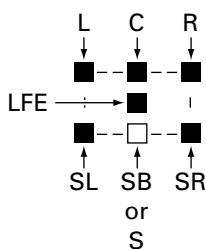

- L** : left channel
- C** : center channel
- R** : right channel
- SL** : left surround channel
- SR** : right surround channel
- SB** : left and right surround back channel
- S** : surround channel
- LFE** : low frequency effect channel
- : identified signal

Example:

5.1 ch encoded Dolby Digital

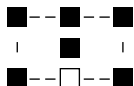

2 ch Dolby Digital

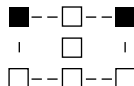

* When an operation is described as [**F.SHIFT → 10 (STATUS)** button], for example, press the **F.SHIFT** button and press the next button (the **10 (STATUS)** button in this case) within 8 seconds.

Input Modes (only for input with digital jacks)

The input mode should usually be set to Full Auto. However, the input mode can also be set manually when you want to fix the inputs as analog signals, etc.

Full Auto : The receiver detects the input signal format and selects the Listen mode automatically according to the speaker setup.

Digital Manual : The inputs are fixed at digital signals and the listen modes should be switched manually by the user.

The **Digital Manual** mode is switched automatically to the **Full Auto** mode when an input is switched or the receiver is set to Off.

Analog : The inputs are fixed at the analog 2-channel inputs.

6ch Input : The inputs are fixed at the analog 6-channel inputs. This mode can be selected only when the DVD input is selected with the input selector.

NOTES

- You cannot select the Input Analog mode if you are playing DTS-encoded media.
- When you use **Full Auto** mode with certain DVD and LD players, performing operations such as "Skip" or "Stop" may momentarily interrupt the output. This could switch the "Listen Mode" automatically to the surround mode intended for the input signal if you have manually selected a different listen mode.
- Different input modes can be selected for the different input devices. The selected input modes for the separate input devices are stored in the memory.
- When playing a DVD Audio disc with a DVD Audio-compatible DVD player:
 1. to reproduce stereo audio, set the input mode of the receiver to **6ch Input**.
 2. to reproduce multi-channel audio, set the input mode of the receiver to **6ch Input**.

Switching Input Modes

To fully enjoy the sonic benefits of specially-encoded DVD AUDIO discs played on a compatible DVD player, you must set the receiver's input to **6Ch Input**.

When you are finished listening to analog media, set the receiver's input back to **Full Auto**.

1. Press the **F.SHIFT → LISTEN M. (INPUT MODE)*** button on Remote Control unit.

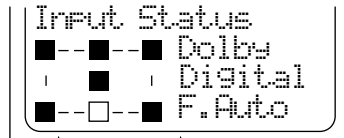

2. Repeat step 1 until the desired input mode is displayed.

Operation on the receiver:

1. Press the **INPUT MODE** button inside the door repeatedly until **FULL AUTO, DIGITAL MANUAL, ANALOG** or **6CH INPUT** is displayed.
- If you turn off the receiver, select a different source device, the "Digital manual" is reset to "Full Auto".
 - When you use "Full Auto" mode with certain DVD and LD players, performing operations such as "Skip" or "Stop" may momentarily interrupt the output.

* When an operation is described as [**F.SHIFT → LISTEN M. (INPUT MODE)** button], for example, press the **F.SHIFT** button and press the next button (the **LISTEN M. (INPUT MODE)** button in this case) within 8 seconds.

To set the THX Mode

Press the **THX** button on Remote Control unit.

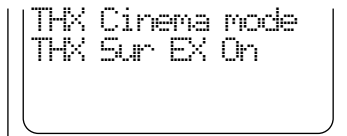
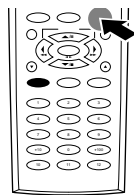

Each press switches the modes as follows.

When the surround back speakers are set to **Lrg** or **Nml/THX**:

- ① THX Sur EX On
- ② THX Sur EX Auto
- ③ THX On
- ④ THX Off

When the surround back speakers are set to **Off**:

- ① THX On
- ② THX Off

Operation on the receiver:

Press the **THX** button inside the door repeatedly until the desired THX mode is displayed.

Each press switches the modes as follows.

When the surround back speakers are set to **Lrg** or **Nml/THX**:

- ① THX Sur EX ON
- ② THX Sur EX AUTO
- ③ THX ON
- ④ THX OFF

When the surround back speakers are set to **Off**:

- ① THX ON
- ② THX OFF

After 3 seconds, the display of the set THX mode returns to the previous display.

- **THX Sur EX On**

The input signal is decoded automatically into 6.1-channel signals if the input signal is Dolby Digital or DTS and contains two channel surround signals.

The THX operation is activated.

- **THX Sur EX Auto**

The input signal is decoded into 6.1-channel signals only when the input contains the Dolby Digital Surround EX encoded identification signal.

The THX operation is activated

- **THX On**

The THX operation is activated. (6.1 channel decoding will not be applied.)

- **THX Off**

The THX Surround EX and THX operations are deactivated.

NOTES

- To play Dolby Digital Surround EX-encoded software in 6.1 channels, it is required to set the THX Surround EX mode to **On** or **Auto**.
Note that some of Dolby Digital Surround EX-encoded software does not contain the identification signal. In this case, set the THX Surround EX mode to **On**.
- Set the THX mode to **Off** when DTS-ES decoding is required.
- The THX operation is not activated with the 96k fs PCM signal.
- When Dolby Pro Logic II: Music is selected while **THX Sur EX On**, **THX Sur EX Auto** or **THX On** is selected, the THX mode will be switched Off.
- As long as Dolby Pro Logic II: Music is selected, switching the THX mode does not produce any effect.
- Different THX modes can be selected for the different input devices. The selected THX modes for the separate input devices are stored in the memory.

How Do I Adjust the Surround Modes?

To set the Listen Mode manually

The listen mode can be set manually except with certain input signals.

1. Press Remote Control unit's **LISTEN M.** button repeatedly until the desired listen mode is displayed.

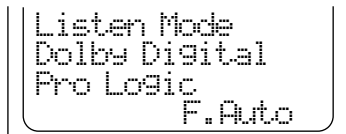
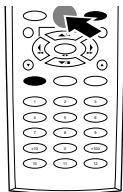

Operation on the receiver:

Press the **LISTEN MODE** button inside the door repeatedly until the desired listen mode is displayed.

After 5 seconds, the display of the set listen mode returns to the previous display.

NOTES

- The available listen modes may be restricted depending on the input signal and speaker setup.
- When the input mode is set to **Full Auto**, if the incoming signal is not **Dolby Digital**, **DTS**, **DTS-ES** or **MPEG**, the listen mode reverts to the last listen mode you selected for that input.
- When the speakers A are set to Off or speakers B are set to On, the listen mode is switched to Stereo.
- Different listen modes can be selected for the different input devices. The selected listen modes for the separate input devices are stored in the memory.

Examples of inputs with which switching is available

when the input signal is Dolby Digital

*Dolby Digital
**PL II : MOVIE
**PL II : MUSIC
****Pro Logic
Stereo

when the input signal is DTS (5.1)

DTS
Stereo

when the input signal is DTS-ES Matrix 6.1

***DTS-ES Mtrx 6.1
Stereo

when the input signal is DTS-ES Discrete 6.1

***DTS-ES Discret 6.1
Stereo

when the input signal is MPEG Multi Channel

Mpeg
****Pro Logic
Stereo

- * When the input signal contains the identification signal indicating Dolby Surround encoding, The listen mode is switched automatically to Pro Logic (Pro Logic II MOVIE).
- ** Pro Logic II (MUSIC/MOVIE) can be selected only when the input is 2-channel signals.
- *** DTS-ES Matrix 6.1/DTS-ES Discrete 6.1 can be selected only when THX mode is OFF.
- **** Pro Logic can be selected only when the input is 2-channel signals.

when the input signal is PCM or Analog

PL II : Movie

PL II : Music

Pro Logic

Neo : Cinema

Neo : Music

*Arena

*Jazz Club

*Cathedral

*Concert Hall

*Stadium 1

*Stadium 2

*Theater 1

*Theater 2

Multi Ch Music

Stereo

- * DSP Modes can be selected only when THX mode is OFF. When the input is a 96k fs PCM signal, it is only Stereo that can be selected.

NOTES

- Some modes may be unable to be selected depending on the speaker setup.
- During playback of a Dolby Digital program, "OFFSET +x dB" (where x is a figure) may be displayed on the receiver's display. This is displayed when the source being played outputs a Dolby Digital signal with a higher or lower level than the standard level. For example, when "OFFSET +4dB" is displayed, the source contains an audio signal with a 4 dB higher level than the standard level. (dB is the unit of sound amplitude.)

Description of Dolby Pro Logic II: Music mode

Panorama mode: Expands the image of front-channel stereo to the surround speakers to create a sound environment that fills your surroundings.

Dimension : This controls the balance between the Front and Rear in 3 steps on the front and 3 steps on the rear. Set this parameter to one of the Front steps if the surround effect is too strong, or to one of the Back steps if it is too weak.

Center Width : The center channel signal can be divided and distributed to the Front L/R channels.





The adjustment for distributing the center channel signal to the front channels can be applied in eight steps from 0 to 7.

Use this adjustment when the center image seems to be too strong.

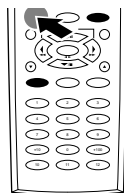

Selecting the parameter of Pro Logic II : Music mode

1. Press the **LISTEN M.** button on the Remote Control unit repeatedly until the PL II : Music mode to be set is displayed.
2. Press the **SOUND** button until "Panorama Off" (or "On") is displayed on Remote Control unit.



3. Press the LCD cursor up/down (/) button on Remote Control unit to select "Panorama On" (or "Off"), then press the **Next** button.
4. Press the **SOUND** button to "Dimension 0" (or "F-1" etc.) is displayed on Remote Control unit.
5. Press the LCD cursor up/down (/) button on Remote Control unit to select "Dimension F-1" (or "F-2", "F-3", "R-1" to "R-3"), then press the **Next** button.







How Do I Adjust the Surround Modes?

6. Press the **SOUND** button to "Center Width 0" (or "1" to "7" etc.) is displayed on Remote Control unit.
7. Press the LCD cursor up/down (/) button on Remote Control unit to select "Center Width 1" (or "0", "2" to "7"), then press the **Home** button.

NOTES

The Center Width is not displayed if the Center speaker is set to "Off" in the speaker setup (see "Setting Up Speakers" on page 36 of the *Connections and Setup Guide*).

Operation on the receiver:

1. Press the **LISTEN MODE** button inside the door repeatedly until the PL II : Music mode to be set is displayed.
2. Press the **SOUND** button repeatedly until to display "PANORAMA OFF" (or "ON").
3. Press the **MULTI CONTROL** (/) button to select "PANORAMA ON" (or "OFF").
4. Press the **SOUND** button to display "DIMENSION 0" (or "F-1" etc.).
5. Press the **MULTI CONTROL** (/) button to select "DIMENSION F-1" (or "F-2", "F-3", "R-1" to "R-3").
6. Press the **SOUND** button to display "CENTER WIDTH 0" (or "1" to "7" etc.).
7. Press the **MULTI CONTROL** (/) button to select "CENTER WIDTH 1" (or "0", "2" to "7").
8. Press the **SOUND** button repeatedly until "**SOUND FIXED**" is displayed.

Applying Digital Signal Processor (DSP) Effects

The DSP mode creates the reverberation devices (elements of sound echoed in various spaces) which determine the feeling of presence. Since DSP uses digital processing, it can produce these effects without soiling the sound quality of the original music or video source.

The DSP mode lets you add the atmosphere of an Arena, Jazz Club, Cathedral, Concert Hall, Stadium (1, 2) or Theater (1, 2) from any PCM or analog input source. These modes are particularly effective when used with stereo program sources like CD, television and FM radio. You might enjoy trying the CONCERT HALL, STADIUM or ARENA mode the next time you watch a sporting event or concert.

You can adjust the following elements to create a customized environment:

- The WALL TYPE parameter lets you adjust the brightness of the sonic environment according to your preference.
- The ROOM SIZE parameter lets you adjust the size of the sonic environment according to your preference.
- The EFFECT LEVEL lets you adjust the amount of DSP “presence” in the sonic environment according to your preference.

Setting a DSP effect

Press the Remote Control unit's **LISTEN M.** button or receiver's **LIS-TEN MODE** button repeatedly until the desired listen mode is displayed.

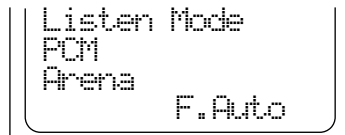
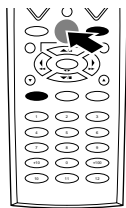

- The DSP mode can be set to Arena, Jazz Club, Cathedral, Concert Hall, Stadium (1, 2) or Theater (1, 2).
- The DSP mode can be selected only when the current input is PCM (except for 96kfs) or Analog.

How Do I Adjust the Surround Modes?

To customize the DSP effect:

1. Press the **SOUND** button and press the **Next** button repeatedly until "DSP Wall Type" is displayed on Remote Control unit.
2. Press the LCD cursor up/down (\triangle / ∇) button on Remote Control unit to select Soft, Medium or Hard.
3. Press Remote Control unit's **Next** button to display DSP Room Size.
4. Press the LCD cursor up/down (\triangle / ∇) button on Remote Control unit to select Small, Medium or Large.
5. Press Remote Control unit's **Next** button.
6. Press the LCD cursor up/down (\triangle / ∇) button on Remote Control unit to select one of Level 1 to Level 9, then press the **Home** button.

Operation on the receiver:

1. Press the **SOUND** button repeatedly until to display WALL type.
2. Press the **MULTI CONTROL** (\triangle / ∇) button to select **SOFT**, **MEDIUM** or **HARD**.
3. Press the **SOUND** button to display ROOM size.
4. Press the **MULTI CONTROL** (\triangle / ∇) button to select **SMALL**, **MEDIUM** or **LARGE**.
5. Press the **SOUND** button to display EFFECT LEVEL.
6. Press the **MULTI CONTROL** (\triangle / ∇) button to select one of LEVEL 1 to LEVEL 9, then press the **SOUND** button repeatedly until "**SOUND FIXED**" is displayed.

HDCD® and D.R.I.V.E. Effects

HDCD is a new format enabling recording with higher quality than previous CD while maintaining compatibility with it. Although a HDCD-compatible CD player is usually required to exhibit the full characteristics of the HDCD, this receiver is capable of reproducing high-quality HDCD signals by connecting a CD player through digital connection, even if it does not incorporate the HDCD circuitry.

D.R.I.V.E. is a KENWOOD original technology for reproducing signals with high resolution by instant switching of the internal filters according to the input signal. This receiver incorporate a high performance DSP to provide very high resolution from 32-bit DRIVE III circuitry, achieving stereo audio reproduction with the best quality ever reached.

The D.R.I.V.E. indicator lights when the D.R.I.V.E. circuit is activated.

The HDCD indicator lights when the HDCD circuit is activated and a HDCD is played.

HDCD and D.R.I.V.E. are designed to be activated automatically to select the optimum circuit path.

NOTES

HDCD and D.R.I.V.E. is effective only at the time of digital input stereo, DSP mode or multi channel music.

Some HDCD-recorded discs do not contain all tracks as HDCD recordings. (The HDCD indicator will not light for tracks not recorded as HDCD.)

HDCD and D.R.I.V.E. is effective only at the time of THX Off mode.

HDCD®, HDCD®, High Definition Compatible Digital® and Pacific Microsonics™ are either registered trademarks or trademarks of Pacific Microsonics, Inc. in the United States and/or other countries. HDCD system manufactured under license from Pacific Microsonics, Inc. This product is covered by one or more of the following: IN the USA: 5,479,168, 5,638,074, 5,640,161, 5,808,574, 5,838,274, 5,854,600, 5,864,311, 5,872,531, and in Australia: 669114. Other patents pending.

How Do I Adjust the Surround Modes?

Headphone Operation

Insert the headphone plug into the receiver's PHONES jack and adjust the listening level.

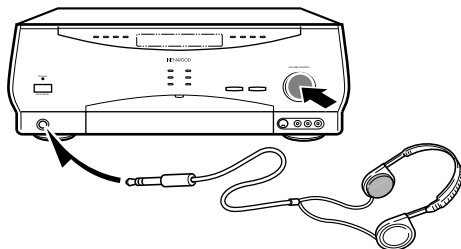

NOTES

When listening through headphones, set **SPEAKERS A** and **B** to **OFF**.

Selecting the Inputs

To select an input on the receiver:

Press one of the **INPUT SELECTOR** ($\triangleleft/\triangleright$) buttons. Each press changes the input in the following order.

- ① Tuner (frequency display)
- ② CD1
- ③ MD/TAPE1
- ④ CD-R
- ⑤ VIDEO1
- ⑥ VIDEO2
- ⑦ VIDEO3
- ⑧ VIDEO4
- ⑨ DVD
- ⑩ AV AUX
- ⑪ PHONO



To return to the previously displayed input, press the other button.

(VR-5080 only)

Although VIDEO4 is displayed in the initial status, the receiver cannot be switched to select VIDEO4. The VIDEO4 display will not appear after Remote Control unit has been set up.

To select an input on Remote Control unit:

The TV-monitored device, video device and audio device can be selected using separate buttons.

Audio device



- ① CD1
- ② MD/TAPE1
- ③ Tuner
- ④ CD-R
- ⑤ PHONO

If any of the above inputs is not identified, the next device name will be displayed.

Video device



- ① VIDEO1
- ② VIDEO2
- ③ VIDEO3
- (④ VIDEO4)
- ⑤ DVD
- ⑥ AV AUX

If any of the above inputs is not identified, the next device name will be displayed.

TV button



- ① TV1
- ② TV2
- ③ CABLE

The TV button cannot select the input. It can be used to remote control TV1, TV2 or CABLE if , devices are identified at these inputs.

How Do I Operate Devices?

Your Remote Control unit makes it easy for you to control the different devices connected to your receiver.

Once AV devices are connected and identified by Remote Control unit , it can use the same remote control functions as the remotes originally provided with the AV devices. (See “Chapter Two: Setting Up Remote Control Unit” of the *Connection and Setup Guide*.)

For the operations of each device, please also refer to the manuals provided with them.

Playback of the device connected to the CD2/TAPE2 MONITOR

These instructions are for operating a second CD player or tape deck from a single-Zone installation or from Zone A. For more information on operating devices in a multi-Zone setup, see “Chapter Two: Using Remote Control Unit in Multiple Zones” on page 54 of this manual.

1. Press the **CD2/TAPE2 MONITOR** button on the receiver’s front panel. The **CD2/TAPE2 MONITOR** indicator lights up.
2. Play the CD player or cassette deck in the same way as usual. As this cannot be controlled from Remote Control unit, use the CD player or cassette deck controls.

After completion of playback, press the **CD2/TAPE2 MONITOR** button again so that the **CD2/TAPE2 MONITOR** indicator goes out.

For detailed operating procedures of your AV device, refer to its instruction manual.

Do not connect the system control cable from the second CD player or second cassette deck, even if it supports system control.

How Do I Operate Devices?

Operating a Television

To operate a standard TV:

1. Press the **TV** button.
2. Use Remote Control unit to perform same remote control operations as with the remote of the TV set.

For the buttons which are usually available, see “Chapter Three: Button Layout in Controlling Other Devices” on page 57.

For detailed operating procedures of your TV, refer to its instruction manual.

The available buttons are variable depending on the TV manufacturer and model. In case of difficulty in remote control, program the desired remote control functions under the desired remote control buttons using the LEARN function (see page 40 of the *Connection and Setup Guide*).

To operate the cable TV and satellite TV:

1. Select the input to which you assigned the cable TV or satellite TV tuner (see page 35).
2. Use Remote Control unit to perform same remote control operations as with the remote of the cable TV or satellite TV tuner.

For detailed operating procedures of your AV device, refer to its instruction manual.

Operating an AV Device

To play a VCR, DVD player or LD player:

1. Select the input you want (see page 35).
2. Use Remote Control unit to perform same remote control operations as with the remote of the selected AV device.

For the buttons which are usually available, see “Chapter Three: Button Layout in Controlling Other Devices” on page 57.

For detailed operating procedures of your AV device, refer to its instruction manual.

The available buttons are variable depending on the AV device manufacturer and model. In case of difficulty in remote control, program the desired remote control functions under the desired remote control buttons using the LEARN function (see page 40 of the *Connection and Setup Guide*).

The channels can be switched using the CH. (+/-) buttons as well as numeric buttons (1 to 12).

Operating a CD player

Kenwood 200-Disc CD Changer

Kenwood 200-Disc CD Changers have many different features that make them ideal complements to your Kenwood receiver. Some changer models can store disc and track titles for all loaded discs, and then download this information to your Remote Control unit.

To play Kenwood 200-Disc CD Changer:

1. Select the **CD** input (see page 35).
2. Use Remote Control unit to perform same remote control operations as with the remote of the CD changer.



You have to assign disc and track titles to the discs in your CD player before you can transfer them to Remote Control unit. See your CD player's instruction manual for more information about assigning disc and track titles.

To read the loaded disc titles and store them in Remote Control unit:

1. Select the CD input and display "Menu".
2. Press the Menu button (LCD function button 2).
3. Select "All Data Read" and press the Enter button (LCD function button 2).
4. Set Remote Control unit down so that its IR transmitter window is aiming at receiver's IR transmitter window. Select Disc Title or Track Title. **Do not** move Remote Control unit while it is reading data.

This process may take some time, depending on how many CDs you have loaded. When the IR light on the receiver goes out, the receiver is done sending the information to Remote Control unit, and you may move Remote Control unit again.

Remote Control unit's memory now contains the disc titles of every CD in the changer with title information.

How Do I Operate Devices?

To play discs and tracks by title:

1. Select the **CD** input (see page 35).

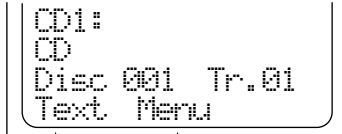

2. Press the Text button (LCD function button 1) to display the disc title menu.



3. Press the LCD cursor up/down (\uparrow/\downarrow) button to select the desired disc, then press the Sel. button (LCD function button 2). The track title menu will appear.

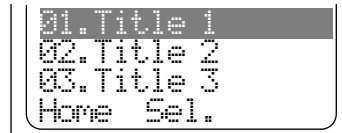

4. Press the LCD cursor up/down (\uparrow/\downarrow) button to select the desired track, then press the Sel. button (LCD function button 2).

Playback will start from the selected track.

The track titles of the presently selected disc can be read by selecting "Track Title" in step 4 of "To read the loaded disc titles and store them in Remote Control unit" on page 39.

Single or Rotary CD Player

1. Select the **CD** input (see page 35).
2. Use Remote Control unit to perform same remote control operations as with the remote of the selected AV device.

The available buttons are variable depending on the AV device manufacturer and model. In case of difficulty in remote control, program the desired remote control functions under the desired remote control buttons using the LEARN function (see page 40 of the *Connection and Setup Guide*).

For the buttons which are usually available, see "Chapter Three: Button Layout in Controlling Other Devices" on page 57.

For detailed operating procedures of your AV device, refer to its instruction manual.

CD-R Recorder

1. Select the **CD-R** input (see page 35).
2. Use Remote Control unit to perform same remote control operations as with the remote of the selected AV device.

The available buttons are variable depending on the AV device manufacturer and model. In case of difficulty in remote control, program the desired remote control functions under the desired remote control buttons using the LEARN function (see page 40 of the *Connection and Setup Guide*).

For the buttons which are usually available, see "Chapter Three: Button Layout in Controlling Other Devices" on page 57.

For detailed operating procedures of your AV device, refer to its instruction manual.

Operating an MD Recorder or Cassette Deck

To play an MD or cassette:

1. Select the input you want (see page 35).
2. Use Remote Control unit to perform same remote control operations as with the remote of the selected AV device.

The available buttons are variable depending on the AV device manufacturer and model. In case of difficulty in remote control, program the desired remote control functions under the desired remote control buttons using the LEARN function (see page 40 of the *Connection and Setup Guide*).

For the buttons which are usually available, see “Chapter Three: Button Layout in Controlling Other Devices” on page 57.

For detailed operating procedures of your AV device, refer to its instruction manual.

How Do I Operate Devices?

Playing an Analog Turntable

To play an analog disk turntable:

1. Select the **PHONO** input (see page 35).
2. Play an analog disk on the turntable. As this cannot be controlled from Remote Control unit, use the turntable controls.

For detailed operating procedures of your AV device, refer to its instruction manual.

Monitoring a Video Camera or Playing an Additional VCR

1. Select the **AV AUX** input (see page 35).
2. Play the video camera or additional VCR in the same way as usual. As this cannot be controlled from Remote Control unit, use the video camera or additional VCR controls.

For detailed operating procedures of your AV device, refer to its instruction manual.

Radio Tuning

Auto: When a tuning button is pressed, the station with the closest frequency to the current frequency position will be tuned in automatically. In this case, the stereo mode is activated automatically when a stereo station is tuned in (FM band only).

Manual: When auto tuning is not available because the radio waves are weak, tune a radio station by selecting its frequency manually. The reception is in monaural during manual tuning. The monaural reception can make the sound easier to listen thanks to less noise than in stereo reception.

Preset tuning :

If you preset (store) radio stations in the receiver, you can tune into any of them by one-touch operations. Up to 40 stations can be preset.

To tune into a radio station:

1. Select the **Tuner** input (see page 35).
2. Select the **FM** or **AM** band.

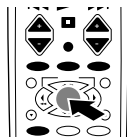
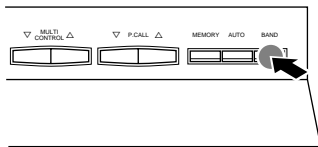

- Press the **BAND** button on the receiver
 - Or press the **ENTER (BAND)** button on Remote Control unit.
3. Press Remote Control unit's **TUNING** (◀/◀◀, ▶/▶▶) button or the receiver's **MULTI CONTROL** (△/▽) button to start Auto tuning until the desired station is tuned in.

If the radio wave from the station is weak and hard to tune in, press the **AUTO/MONO** buttons on Remote Control unit or **AUTO** button on the receiver to select Manual tuning. In this mode, each press of the **TUNING** button varies the tuning frequency by one step.

Presetting radio stations

The following operation should be performed on the receiver.

1. Tune into a desired station.
2. Press the **MEMORY** button.
3. Press Remote Control unit's **TUNING** (◀/◀◀, ▶/▶▶) button or press the receiver's **P.CALL** (△/▽) button to display the desired preset memory bank number.
4. Press the **MEMORY** button to preset the station under that number.
5. To preset other stations, repeat steps 2 to 5 for each.

To tune into a preset station:

1. Select the **Tuner** input (see page 35).
2. Press Remote Control unit's **◀◀** or **▶▶** button or the receiver's **P.CALL** (Δ/∇) button. Each press of the button switches the preset station (see "Presetting radio stations" on page 45).

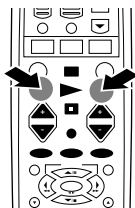

When select a preset station using the numeric buttons: Press the numeric buttons as shown below.

To select 25: $\textcircled{+10}$, $\textcircled{+10}$, $\textcircled{5}$

Recording

To record audio/video:

1. Select the recording input source device such as a AV device or tuner (see page 35).
2. Use Remote Control unit to select the channel and perform other required operations in the same way as with the remote of the selected AV device.
3. Press and hold the remote's **CONFIRM/SHIFT** button for about 2 seconds so that the **Shift** display appears, then select the recording device such as the VCR. For 8 seconds after the CONFIRM/SHIFT button is pressed, the input selection signal is not transmitted from the remote to the receiver even when an input is selected. Therefore, this period can be used to remote control the recording device without changing the input selection.
4. Press the remote's **REC** button to start recording.

For detailed operating procedures of your AV device, refer to its instruction manual.

NOTES

To record a source connected through [SL 16] system control cord:

When recording audio from a CD player connected through a system control cord, the sync recording is available. (For the sync or synchro recording, refer to the instruction manual of your cassette deck or MD recorder.)

1. Select the **CD** input on Remote Control unit.
2. Put the cassette deck or MD recorder in Rec pause mode. When the CD starts to be played, recording is automatically started in synchronism.



- If you're recording from a digital source, any action other than adjusting the volume may cause the sound to "clip" on the recording.
- You cannot record from the component you are using to record. For example, if you're recording on a VCR connected to the VIDEO 1 jacks, select a source other than Video 1.
- If your source is a camcorder or other video unit, refer to the instruction manual for the particular unit you're recording from.

Digital to Digital Recording:

The PCM digital signal input through any DIGITAL IN jack is output digitally at the digital jack. For more information on this connection, see "Connecting Your MD Recorder or Primary Tape Deck" on page 22 of the *Connections and Setup Guide*.

Dolby Digital, DTS and MPEG Multichannel signals cannot be recorded.

Digital to Analog Recording:

While home VCRs can record only two channels of audio, the receiver is capable of "down-mixing" the multi-channel audio of Dolby Digital, DTS or MPEG into stereo sound. Down-mixing is available by setting the Digital Rec mode to "REC MODE: AUTO" or "REC MODE: MANUAL".

Digital Rec mode:

Digital signals include a variety of signals such as the Dolby Digital, DTS and PCM signals.

When **REC MODE** is set to **AUTO**, digital input signals are automatically converted into analog stereo signals.

When **REC MODE** is set to **MANUAL**, only a specific signal among the digital signals can be converted into analog stereo signals.

When **REC MODE** is switched to **MANUAL** in the middle of reproduction of a digital audio program, only the digital signal of the type being reproduced will be converted into analog stereo signals.

When **REC MODE** is switched to **MANUAL** while no source is played, only the PCM signal will be converted into analog stereo signals.

How Do I Operate Devices?

To set the Digital Rec mode:

1. Press the **F. SHIFT → REC (REC MODE)*** button on Remote Control unit.
2. Select "Rec Mode Auto" or "Rec Mode Manual".

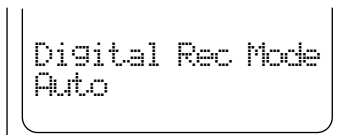

NOTES

It is not possible to recording monitor a digital source signal onto the device connected to the **CD2/TAPE2 MONITOR** input.

When a source recorded by down-mixing a multi-channel source is played back in the Dolby Pro Logic mode, the audio can be reproduced in 4-channel surround sound.

* When an operation is described as [**F.SHIFT → REC (REC MODE)** button], for example, press the **F.SHIFT** button and press the next button (the **REC (REC MODE)** button in this case) within 8 seconds.

How Do I Adjust the LCD Display?

Using Remote Control unit under low light

When using Remote Control unit under low light, the backlight of the LCD display can be turned on.

- Press and hold the **F.SHIFT** button for more than 2 seconds.

The backlight is turned on and off every 2 seconds of holding.

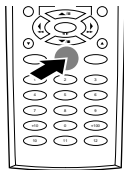





If the  is blinked, the backlight cannot be turned on because the batteries are nearly exhausted.

(Replace with new batteries)

Adjusting the contrast of LCD display

The contrast of the LCD display can be adjusted to improve the visibility.

1. Press the Music button or Movie button to display "Menu".
2. Press the Menu (LCD function button 2) button.
3. Press the Setup (LCD function button 2) button.
4. Press the LCD cursor up/down (/) button to select "03. Contrast", then press the Enter button.
5. Select the desired contrast with the LCD cursor up/down (/) button. The previous menu re-appears in about 3 seconds after the above operation.

Adjusting the brightness of receiver

When the ambient light is low, for example in the night, the brightness of the receiver's display can be dimmed and LED indicators (THX, DTS, D.R.I.V.E., DOLBY DIGITAL, MPEG, HDCD and 2-way communication indicator) can be disabled.

- Press the **F.SHIFT → SOUND (DIMMER)*** buttons. Each press of the **SOUND (DIMMER)** button switches the brightness as shown below.

➤ ①	Display/bright	Indicators/enabled
②	Display/dim	Indicators/enabled
③	Display/dim	Indicators/disabled

Selecting the display mode of receiver front panel

- Press and hold the **LISTEN MODE (DISPLAY)** button on the receiver for more than 2 seconds.

The displayed information is switched every 2 seconds of holding the button.

A: Connected Device	Input Mode
DVD	AUTO
B: Input Terminal	Connected Device
VIDEO3 :	DVD
C: Listen Mode	

DOLBY DIGITAL

"Input Mode" is displayed only when a selector with digital input is selected.

When the selected input is **PHONO** or **TUNER**, the connected device and listen mode are displayed alternately. (Switching between A and C). "Input mode" and "Connected Device" do not be displayed.

The **TUNER** display shows the frequency.

* When an operation is described as [**F.SHIFT → SOUND (DIMMER)** button], for example, press the **F.SHIFT** button and press the next button (the **SOUND (DIMMER)** button in this case) within 8 seconds.

Executing Several Operations at Once (Macro function)

By registering several steps of remote control operations beforehand, these operations can be executed with a single operation. This function is referred to as the macro function. The receiver can register up to three sets of macros. Up to 20 operation steps can be recorded for one macro.

Registering a macro

1. Press and hold the **MACRO** button on Remote Control unit for more than 2 seconds.

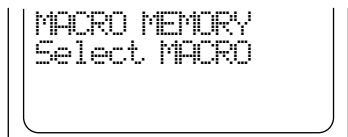

2. Within 8 seconds, press the **MUSIC** (MACRO1), **MOVIE** (MACRO2) or **TV** (MACRO3) button.

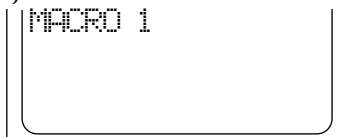

3. Press the control buttons in the order you want to execute them.
4. Press the **MACRO** button. Now the registration is complete.
5. Check the macro according to the following "Executing a macro" procedure.

When there is a function which does not perform interim operation, a delay must be inserted. To insert a delay, insert a macro step for a button not related to the operation at that time (for example the STOP button during stop) etc. before the function for which the operation is to be delayed.

Press each button slowly and firmly.

"Full" is displayed when the maximum number of steps have been registered.

If you do not perform any operation for more than 8 seconds in the middle of registration, the registration mode is canceled and the previous registration remains without being cleared.

Executing Several Operations at Once (Macro function)

Example of registration:

In the following example, the steps for turning the TV on, turning the VCR on, setting the TV channel and playing the VCR will be registered in MACRO 2.

1. Press and hold the **MACRO** button on Remote Control unit for more than 2 seconds.
2. Within 8 seconds, press the **MOVIE** (MACRO2) button.
3. Perform registration.
 1. Press the **TV** button to select TV.
 2. Press the **AV POWER** button.
 3. Press the **MOVIE** button.
 4. Press the **AV POWER** button.
 5. Press the **▶** button.
4. Press the **MACRO** button.

Now the registration is complete.

Executing a macro

1. Press the **MACRO** button on Remote Control unit.
2. Within 3 seconds, press the **MUSIC** (MACRO1), **MOVIE** (MACRO2) or **TV** (MACRO3) button.

The registered macro will be executed.

After macro execution, the LCD display returns to the previous condition.

Using Remote Control Unit in Multiple Zones

The VR-5700/VR-5090/VR-5080 offers dual-zone output and control, which enables you to use a single receiver to control devices and speakers for 2 zones. Due to its advanced features and controls, you can listen to music in one zone while a movie plays in the other!

Depending on your tastes and budget, you can set up one of the following “sound scenarios” to make full use of the VR-5700/VR-5090/VR-5080’s capabilities:

No additional amplifier for Zone B: You can use your receiver’s Speaker B output for Zone B. This allows you to listen to full surround sound in Zone A only, or in stereo in Zone A when Zone B is active. The sound in Zone B will always be in stereo.

Stereo amplifier for Zone B: You use an additional stereo amplifier for Zone B (connected to the receiver’s Second Zone Preouts). This allows you to hear full surround sound in Zone A even if you are also listening in Zone B. The sound in Zone B will always be in stereo.

This section covers only multiple-zone operation of the receiver. See Chapter Two for general operating instructions.

How Do I Switch Control Modes?

You can use Remote Control unit to operate your receiver and source devices from 2 different zones. To do so, you need to switch control modes to control the devices from each zone.

To make operations from Zone B easier, we recommend that you purchase a second Remote Control unit. That way you can leave one Remote Control unit in Zone A that is always set up for Zone A operation, and another Remote Control unit in Zone B that is always set up for Zone B operation.



Some system control features are not available when the Remote control unit is set up for multi-zone control.

To switch control modes for Zone A or Zone B:

1. Press the **F. SHIFT → 11 (MULTI ZONE)*** button on Remote Control unit.

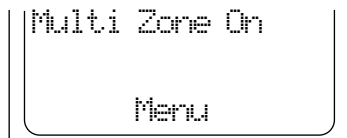
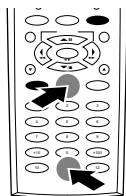

Each time the **F. SHIFT → 11 (MULTI ZONE)*** button is pressed, switches the On and Off.

Operating Devices in Zone B

1. Press the **F. SHIFT → 12 (ZONE A/B)*** button on Remote Control unit.

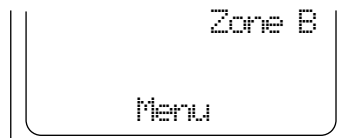
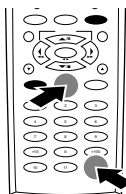

Each time the **F. SHIFT → 12 (ZONE A/B)*** button is pressed, switches Zone A and Zone B.

NOTES

Devices connected via digital jacks only cannot be listened to in Zone B. We recommend that you connect the analog jacks of all devices. You must use the composite video connections. Only video sources connected with composite connectors can be viewed in the second zone.

* When an operation is described as [**F.SHIFT → 11 (MULTI ZONE)** button], for example, press the **F.SHIFT** button and press the next button (the **11 (MULTI ZONE)** button in this case) within 8 seconds.

Operation using the SYS.POWER button on Remote Control unit

To perform the Multi-Zone operation, switch the Multi Zone function On in advance (see page 55).

1. When the receiver is OFF (STANDBY mode):
 - To output the video and audio to Zone A, set the Zone setting of the remote to Zone A then press the SYS.POWER button on the remote.
 - To output the video and audio to Zone B, set the Zone setting of the remote to Zone B then press the SYS.POWER button on the remote.
2. When the video and audio are output to Zone A only:
 - To turn the receiver OFF (STANDBY mode), set the Zone setting of the remote to Zone A then press the SYS.POWER button on the remote.
 - To output the video and audio to Zone B, set the Zone setting of the remote to Zone B then press the SYS.POWER button on the remote.
3. When the video and audio are output to Zone B only:
 - To turn the receiver OFF (STANDBY mode), set the Zone setting of the remote to Zone B then press the SYS.POWER button on the remote.
 - To output the video and audio to Zone A, set the Zone setting of the remote to Zone A then press the SYS.POWER button on the remote.
4. When the video and audio are output to both Zone A and Zone B:
 - To turn the receiver OFF (STANDBY mode), set the Zone setting of the remote to Zone A then press the SYS.POWER button on the remote.
 - To defeat the video and audio outputs to Zone B, set the Zone setting of the remote to Zone B then press the SYS.POWER button on the remote.



The receiver can also be turned OFF (STANDBY mode) by pressing the POWER button on the receiver.

Chapter Three: Button Layout in Controlling Other Devices



The remote control unit provided with the receiver can also control a variety of AV devices. As the functions of the buttons are variable depending on the controlled device, it is recommended to control each device by referring to a function chart. The following three kinds of buttons are used to control their respective functions.



1. Remote control buttons

The buttons which are operated in the same way as ordinary remote control are referred to as remote control buttons.

- ① Select the device to be controlled by pressing the **MUSIC** button, **MOVIE** button or **TV** button.
- ② Press the button corresponding to the desired operation.

2. Display buttons

Pressing the LCD function buttons (, ) and LCD cursor up/down buttons () displays a menu for use in control.

- ① Select the device to be controlled by pressing the **MUSIC** button, **MOVIE** button or **TV** button.
- ② Press the Menu button (LCD function button 2) to display the control menu.
- ③ Select the controlled item by pressing the LCD cursor up/down button () then press the LCD function button 2 () to set the selection.

3. F.SHIFT button

In addition to the functions displayed on remote control buttons, the functions displayed in blue characters on the panel above the buttons can also be used. To use one of them, press the **F.SHIFT** button then press the desired button within 8 seconds.

(Example) To use the REPEAT function: Press the **F.SHIFT** button then press the **1(REPEAT)** button.

NOTES

1. Although the remote control unit provided with the receiver has been designed to be used in remote control of multiple devices, there may be certain devices which cannot be remote controlled by it.
2. Certain devices may function differently from the intended function.

Tuner Operation

AV POWER 1/5

: P.CALL DOWN **BAND**
 : P.CALL UP **AUTO/MONO**
TUNING ◀
TUNING ▶

REPEAT 1	RANDOM 2	INPUT SEL. 3
TV SELECT 4	DISPLAY 5	SELECT 6
AUDIO 7	THEME 8	FAVORITE 9
INFO. +10	EXIT 0	LAST CHANNEL +100
STATUS 10	MULTI ZONE 11	ZONE A/B 12

Numeric buttons (0 to 9, +10)

Cassette deck Operation

AV POWER 1/5

: Play (▶) (A) **ENTER** : Play (▶) (B)
 : Pause (A) **▲/||** : Pause (B)
 : Stop (A) **◀◀** : F. Rewind (B)
 : F. Rewind (A) **▶▶** : F. Forward (B)
 : F. Forward (A) **▼/■** : Stop (B)

Use with F.SHIFT button : **ENTER** : Play (◀) (B)

Use with F.SHIFT button : **Display buttons**
 01 - 05 : Extend 1 - 5
 There may be certain devices which cannot be remote controlled by it.

REC : Record (B)

CD Player Operation

AV POWER 1/3

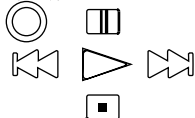

TITLEGUIDE

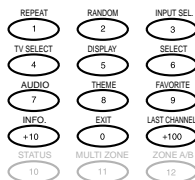
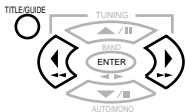

: Pause

: Play/Pause

: Stop

: Skip (Reverse)

: Skip (Forward)

: Disc select
(DISC Up)

: Disc select
(DISC Down)

:
F. Backward

: F. Forward

TITLEGUIDE

: Track Title

Numeric buttons
(0 to 9, +10, +100)

Use with F.SHIFT
button :

- 1 : Repeat
- 2 : Random
- 5 : Display

Display buttons

01 : Disc sel.

02 : Set

03 : P.Mode

04 : Check

05 : Clear

06 : Disc Title

07 : Track Title

08 : All Data Read

09 : Subout Mon
(Subout Monitor)

10 : Cnts Play

(Continuous Play)

11 : All Info.

Display buttons

12 - 16: Extend 1-5

(there may be certain
devices which cannot
be remote controlled
by it.)

There may be certain devices which cannot be remote controlled by it.

CD-R Recorder Operation

AV POWER I/O

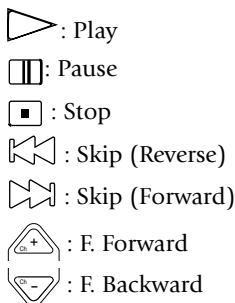
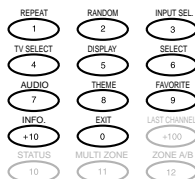
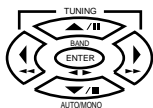
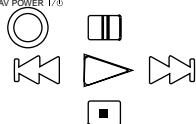

ENTER: Enter
 ▲ : Cursor UP
 ▼ : Cursor DOWN
 ◀ : Cursor Left
 ▶ : Cursor Right



REC : Record

Numeric buttons
 (0 to 9, +10)

Use with F.SHIFT
 button :

- 1 : Repeat
- 2 : Shuffle/
Random
- 5 : Display

Display buttons

- 01 : Open/Close
- 02 : CDR Mode
- 03 : CD Mode
- 04 : Program
- 05 : Rec Mute
- 06 : Clear

Display buttons

- 07 - 11 : Extend 1 - 5

There may be certain devices which cannot be remote controlled by it.

MD Player Operation

AV POWER 1/3

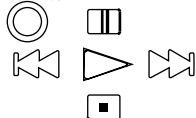

 : Play

 : Pause

 : Stop

 : Skip (Reverse)

 : Skip (Forward)

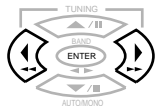

 : F. Backward

 : F. Forward



REC : Record

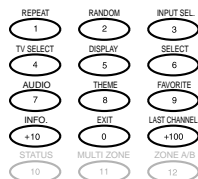

Numeric buttons
(0 to 9, +10, +100)

Use with F.SHIFT
button :

1 : Repeat

2 : Random

5 : Time

Display buttons

01 - 05 : Extend 1 - 5

(there may be certain devices which cannot be remote controlled by it.)

There may be certain devices which cannot be remote controlled by it.

DVD Player Operation

AV POWER 1/5

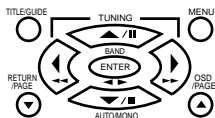
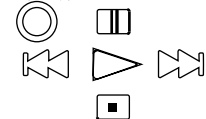

 : Play

 : Pause

 : Stop

 : Skip (Reverse)

 : Skip (Forward)

 : F. Forward

 : F. Backward

Use with F.SHIFT button :

 : Slow Reverse

 : Slow Forward

Display buttons

01 : Disc Sel

02 : Chapter/Time

03 : Angle

04 : PGM

05 : DVD Setup

06 : Memory

07 : Clear

08 : Repeat A-B

ENTER : Enter

▲ : Cursor Up

▼ : Cursor Down

◀ : Cursor Left

▶ : Cursor Right

 : Menu

 : Title

 : OSD

 : Return

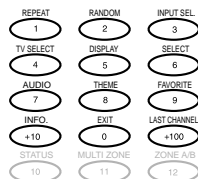

Numeric buttons

(0 to 9, +10, +100)

Use with F.SHIFT button :

1 : Repeat

2 : Random

5 : Display

7 : Audio

09 : Sub Title

10 : Title Search

11 : Disc Title

12 : Track Title

13 : All Data Read

14 : Aspect

15 : On/Off

16 - 20 : Extend1 - 5

There may be certain devices which cannot be remote controlled by it.

VCR Operation

AV POWER 1/3

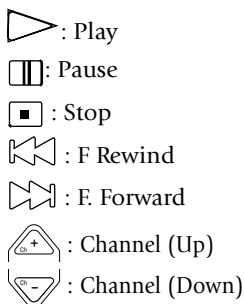
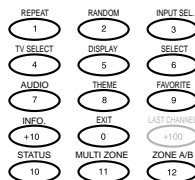
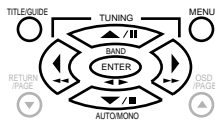
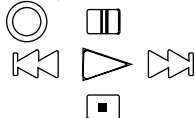

ENTER : Enter
 ▲ : Cursor Up
 ▼ : Cursor Down
 ◀ : Cursor Left
 ▶ : Cursor Right

MENU : Menu
 TITLEGUIDE : Guide

REC : Record

Numeric buttons
 (0 to 9, +10)

Use with F.SHIFT
 button :
 3 : Input select

Display buttons

01 : Thumb Up
 02 : Thumb Down
 03 : Jump
 04 : Inst. Replay
 05 : Quick Skip
 06 : Exit

Display buttons

07 - 11 : Extend1 - 5

There may be certain devices which cannot be remote controlled by it.

LD Player Operation

AV POWER 1/5

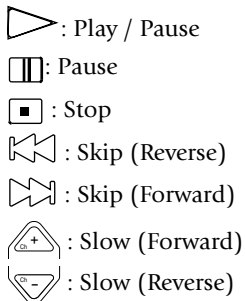
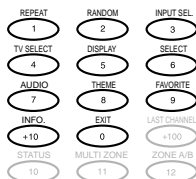
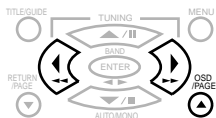
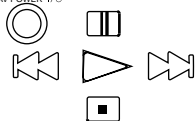

ENTER: Enter
 : F. Backward
 : F. Forward
 : OSD

Numeric buttons
(0 to 9, +10)

Use with F.SHIFT
button :

- 1 : Repeat
- 2 : Random
- 5 : Display

Display buttons

- 01 : Frame/Time
- 02 : Side A or A/B
- 03 : Side B

Display buttons

- 04 - 08 : Extend 1 - 5

There may be certain devices which cannot be remote controlled by it.

TV Operation

AV POWER 1/0

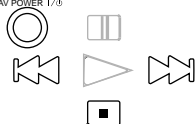

- : Mute
- : Volume (Down)
- : Volume (Up)
- : Channel (Up)
- : Channel (Down)

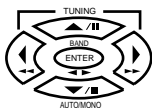

- ENTER : Enter
- ▲ : Cursor Up
- ▼ : Cursor Down
- ◀ : Cursor Left
- ▶ : Cursor Right

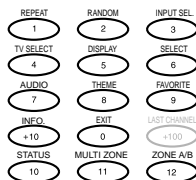

Numeric buttons
(0 to 9, +10)

Use with F.SHIFT
button :

- 3 : Video Select
- 4 : TV Select
- 7 : Alt. Audio

Display buttons

- 01 : - / - -
- 02 : > 12
- 03 : Wide
- 04 : Pic. In Pic. (Picture in picture)
- 05 : Text/Mix/TV
- 06 : Text off
- 07 : Mix
- 08 : Exit

Display buttons

- 09 - 13 : Extend1 - 5

There may be certain devices which cannot be remote controlled by it.

Cable TV Player Operation

AV POWER I/O

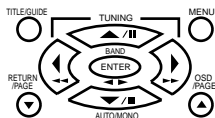

Volume (Down)



Volume (Up)



Channel (Up)



Channel (Down)

ENTER : Enter

▲ : Cursor UP

▼ : Cursor DOWN

◀ : Cursor Left

▶ : Cursor Right

MENU



: Menu

TITLE/GUIDE



: Guide

OSD/PAGE



: Page Up

RETURN/PAGE



: Page Down

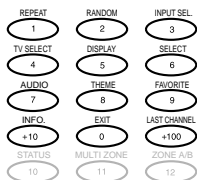

Numeric buttons
(0 to 9, +10, +100)

Use with F.SHIFT
button :

0 : Exit

3 : Input Select

5 : OSD

6 : Select

8 : Theme

9 : Fav.

+10 : Info.

+100:Last Channel

Display buttons

01 : A

02 : B

03 : C

04 - 08 : Extend1 - 5

There may be certain devices which cannot be remote controlled by it.

Satellite tuner Operation

AV POWER 1/5

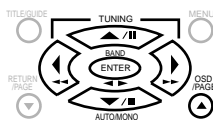

: Channel (Up)



: Channel (Down)

ENTER : Enter

▲ : Cursor Up

▼ : Cursor Down

◀ : Cursor Left

▶ : Cursor Right



: OSD

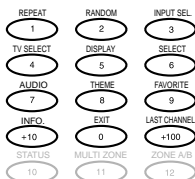

Numeric buttons
(0 to 9, +10, +100)

Use with F.SHIFT
button :

3 : Input Select

6 : Select

7 : Alt. Audio

Display buttons

01 - 05 : Extend1 - 5

There may be certain devices which cannot be remote controlled by it.

DSS Operation

AV POWER I/O

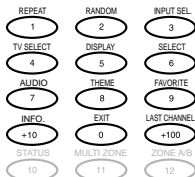
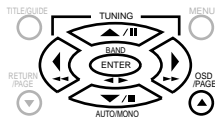

: Channel (Up)

: Channel (Down)

ENTER : Enter

▲ : Cursor Up

▼ : Cursor Down

◀ : Cursor Left

▶ : Cursor Right

MENU

○ : Menu

TITLEGUIDE

○ : CH Guide

Numeric buttons
(0 to 9, +10,+100)

Use with F.SHIFT
button :

3 : Input Select

6 : Select

7 : Alt. Audio

8 : Theme

9 : Fav.

+10 : Info.

Display buttons

01 : Exit

02 - 06 : Extend1 - 5

There may be certain devices which cannot be remote controlled by it.

Chapter Four: Troubleshooting

Troubleshooting is how you determine what part of a complex system (like a home theater system) is at fault when the system isn't working how you think it should. When you troubleshoot a system, you diagnose a problem by examining and eliminating possible causes until there's only one left. Troubleshooting is easiest when you start with the most obvious, most common, and most likely and work from there.

Diagnosing your own problems can save you time and aggravation—the better you understand how to troubleshoot and adjust your own system, the less time you have to:

- spend on the phone with a customer service representative
- do without your receiver because it's "in the shop"

There are some basic steps to good troubleshooting:

1. **Verify the exact conditions when the problem occurs.**

This is the most important step in troubleshooting. Whether you fix it yourself or have to describe it to a technician, you are much more likely to really solve the problem if you know the exact circumstances surrounding the problem. For example, if you don't hear anything through the speakers, it's useful to know if it only happens when you are listening to CDs. Knowing that eliminates the speakers themselves as part of the problem. The more you know about when a problem occurs, the more likely it is that you or the technician can solve it.

2. **Check each part of the signal's path from source (such as a CD player) to speaker.**

You may also want to test the assumptions you made in step 1: maybe you haven't listened to your MD recorder in a while— is there no sound from it as well? This step will really help narrow down the possible causes. Test all your connected components and eliminate the ones where the problem doesn't occur. When you're done with this step, you'll probably have found the problem.

3. Go over all component connections slowly and methodically. Double-check the settings on your remote.

Wrong or loose connections are the most likely cause of the most common home entertainment problem: no sound. Use the *Connection and Setup Guide* to double-check your connections for each component. This is especially important with VCRs, tape decks, MD recorders, and equalizers, where it's very easy to swap the "play" and "record" connections.

For the VR-5700/VR-5090/VF-5080, you should also check your Remote Control unit settings carefully. Did you set the input to the correct component? (you can also check the front panel of the receiver) Are you trying to listen to an analog source using a digital connection?

4. Cables (especially old ones) go bad more frequently than components do.

Always suspect the cable before its component. For one thing, it's easier to test: simply swap the cable with one connected to a component you know *is* working. If the problem component works now, it was the cable. You can generally purchase new cables at most home electronics stores, or via the Internet.

5. User error is more likely than component failure.

You probably don't want to hear this, but it's true. Use this manual to go over the steps to operate the receiver. Refer to the other components' manuals as well.

6. Instruction manuals are your friend.

A good rule of thumb is to check the manual when something doesn't work how you expected it to. If you read the manual before calling the store or taking the component back, you may find the solution to your problem much more quickly.

The rest of this chapter presents some common problems, grouped by type, and the steps you can take to resolve them.

Sound

I don't hear any sound at all

Check that:

- The volume is set at the proper level. See "Adjusting the Volume" on page 10 of this manual.
- Mute is **OFF**. If the **MUTE** indicator on the front of the receiver is blinking, **MUTE is ON**. See "Muting Sound" on page 16 of this manual.
- The proper input (e.g., CD player, Tuner, etc.) has been selected on the Remote Control unit. See "How Do I Operate Devices?" on page 36 of this manual.
- The proper zone has been selected. See "How Do I Switch Control Modes?" on page 54 of this manual.
- The **CD2/TAPE2 MONITOR** input has not been selected. (If it has, the **CD2/TAPE2 MONITOR** indicator on the receiver's front panel will be lit). See "What's on the Front Panel of Your Kenwood Audio - Video Receiver?" on page 2 of this manual.
- The input mode matches the input signal (e.g., analog vs. digital) that has been set. See "Switching Input Modes" on page 23 of this manual.
- The correct Input Mode (e.g., Full Auto) has been set for the digital input. See "Input Modes" on page 22.
- The correct speakers have been activated. See "Turning the Speakers On" on page 9 of this manual.

Audio is not output only when a 96k fs compatible disc is played.

- The optical cable may be bent. Use a new optical cable.
- Check that the optical cable connector is connected properly.
- Certain DVD player models inhibit digital output. Use analog cables with such a DVD player.

The 96k fs indicator does not light while a 96k fs compatible disc is being played.

- The indicator will not light unless the DVD player is properly set.

I can't hear sound from one or more of the speakers, or the sound is abnormally low

Check that:

- All of the speaker wires are connected tightly, not short circuited. See Chapter One of the *Connections and Setup Guide*.
- All of the speakers have been activated in the Setup Speakers menu. See Chapter Two of the *Connections and Setup Guide*.
- The individual speaker levels are set properly. See Chapter Two of the *Connections and Setup Guide*.
- The **CD2/TAPE2 MONITOR** input has not been selected. (If it has, the **CD2/TAPE2 MONITOR** monitor indicator on the receiver's front panel will be lit). See "What's on the Front Panel of Your Kenwood Audio - Video Receiver?" on page 2 of this manual.
- The correct speakers have been activated. See "Turning the Speakers On" on page 9 of this manual.
- The correct listen mode has been selected. See "What are Listen Modes?" on page 18 of this manual.

I can't hear sound from my surround or center speakers

Check that:

- The proper surround play mode (Dolby Pro Logic, Dolby Pro Logic II, DSP, MPEG, DTS NEO:6, DTS, DTS-ES or Dolby Digital) has been selected. See "What are Listen Modes?" on page 18 of this manual.
- All of the speaker wires are connected tightly. See Chapter One of the *Connections and Setup Guide*.

I can hear sound only from the center speaker when Dolby Pro Logic is selected

Check that the program (e.g., TV show, radio station, VCR tape) is in stereo. Programs in mono play only through the center speaker when the receiver is in the Dolby Pro Logic listen mode.

A DTS-ES encoded source is played but it is not decoded in DTS-ES.

- DTS-ES decoding in playback is not available if THX is set to THX Surround EX On, THX Surround EX Auto or THX is On. Set THX to Off. See "To set the THX Mode" on page 24 of this manual.

A Dolby Digital Surround EX-encoded source is played with THX Surround EX set to "Auto", but the source is not reproduced in 6.1-channel audio.

- Some encoded sources (discs) do not contain the recording of the encoding identification signal. To reproduce such sources in 6.1-channel audio, set THX Surround EX to ON. See "To set the THX Mode" on page 24 of this manual.

Sound from one (or more) of my components is abnormally loud or soft

Adjust the analog input level for that component: See "Adjusting the Input Level" on page 15 of this manual.

I can't hear sound from some of my laser discs

Check that the disc contains a digital soundtrack (the disc's cover will bear a "digital sound" logo). Some older laser discs contain only analog soundtracks. If the disc does not have a digital soundtrack, change the input type to Analog. See "Switching Input Modes" on page 23 of this manual and also read the manual of your laser disc player.

There wasn't any sound recorded on tapes made on my VCR or tape deck

Check that:

- The audio cables are connected properly for the component.
- The source is connected via an analog jack set . See Chapter One of the *Connections and Setup Guide*.
- Analog has been set as the input mode. Digital inputs such as Dolby Digital, DTS or MPEG need to be downmixed into two channels for recording to analog media (such as VHS or audio tape). See "Digital to Analog Recording" on page 48.

The initial sound is intermittent or non-existent when I start to play from a Dolby Digital, DTS, DTS-ES or MPEG source

- Some DVD players simply have intermittent start-up sound.
- Check that the correct digital cable is being used. The cable must be a *digital* coaxial or optical cable. See Chapter One of the *Connections and Setup Guide*.

With a Dolby Digital program or DTS program, the loud sounds aren't very loud and the quiet sounds aren't very quiet

Check that volume extremes are not automatically being balanced. See "Midnight Theater Function" on page 16 of this manual.

All I hear is loud static when I play DTS discs

- Check that Digital has been set as the input mode. DTS discs do not output analog sound. See "Switching Input Modes" on page 23.
- DTS discs can only be played in Zone A

I hear a hum when I select the PHONO input

Check that:

- The audio cables are connected securely to the Phono jack set. See Chapter One of the *Connections and Setup Guide*.
- The turntable is grounded on the receiver. See Chapter One of the *Connections and Setup Guide*.

Sound is intermittent

Attach the provided protective cap to the unused OPTICAL inputs. If the light from a fluorescent lamp or direct sunlight enters through this connector, the played audio will be intermittent.

I can't hear any sound in Zone B

Check that:

- Multiple Zones is activated.
- The volume in Zone B is turned up. See "Operating Devices in Zone B?" on page 55 of this manual.
- The Zone B speakers are turned on if using Speaker B outputs for Zone B (as opposed to Second Zone Pre Outs). See "Turning the Speakers On" on page 9 of this manual.
- The source is connected via an analog jack set (digital inputs are not sent to Zone B). See Chapter One of the *Connections and Setup Guide*.

Video

I can't see the program I'm playing on the TV. There wasn't any video output to my VCR when I recorded

- Check that the video source and TV are connected via the same type of connectors (For VR-5080).

Video/Remote Control unit

- Check that the correct video input on the TV is selected.
- Check that the video software you record does not have copy guard protection.
- All Zone B inputs must be composite. S-Video is not supported in Zone B.

Remote Control unit



My Remote Control unit is slow to respond—sometimes I have to press buttons or select commands several times

- If Remote Control unit is in sleep mode (the screen is blank), the first button press “wakes it up”. The second press performs the action.
- Your Remote Control unit supports 2-way communication with the receiver. If the 2-way communication indicator on the front of the receiver is lit, Remote Control unit is receiving information. It cannot transmit your new command until it is finished receiving information from the receiver.

My Remote Control unit is not responding

- Make sure you are within the operating range for Remote Control unit. See “Remote controllable range” on page 7 of this manual.
- Replace the batteries. See Chapter Two of the *Connections and Setup Guide*.
- If you’re using an IR receiver, make sure it is connected properly and turned on. See Chapter four of the *Connections and Setup Guide*.
- Check the contrast of the LCD display is adjusted properly. See “How Do I Adjust the LCD Display” on page 50.
- When the **RF ON/OFF (INPUT MODE)** button is pressed for 2 seconds or longer, “RF OFF” will be displayed. In this condition, the main unit can not receive remote control signals. Press the **RF ON/OFF (INPUT MODE)** button again for at least 2 seconds to display “RF ON”. See page 49 of the *Connections and Setup Guide*.
- If you want to use Remote Control unit by setting the control mode to Zone B, make sure that the Multi-Zone function is On. If this function is Off, you cannot control Zone B from Remote Control unit.

I want to clear all the items in Remote Control unit and make it to the factory-set default condition.

1. Remove the batteries.
2. While holding the  (function up) button and  button simultaneously, load the batteries.

After the above, all settings are reset to the factory settings.

The RF remote control function does not work.

- Connect the antenna. See page 33 of the *Connections and Setup Guide*.
- Make sure that the correct RF band is selected. See page 43 of the *Connections and Setup Guide*.
- The operation range of the Remote Control unit will be influenced according to the material of the obstacles between the Remote Control unit and the receiver. Please confirm that there is no such influence.
- Make sure that no interference from electrical appliances occurs.

Receiver/Tuner

My receiver won't turn on and the STANDBY indicator is flashing

Your receiver is in the "protection" mode.

Check that:

- The speaker system's impedance is not too low. See Chapter One of the *Connections and Setup Guide*.
- The speaker wires are not short-circuited. Test the wires as follows to find the shorted wire and replace it:
 - ① Turn off the receiver, disconnect the positive and negative speaker wires of the **RIGHT FRONT** speaker from the receiver, and turn the receiver back on.
 - ② If the **STANDBY** indicator stops flashing, replace this wire.
 - ③ If the **STANDBY** indicator does not stop flashing, turn off the receiver, reconnect the speaker wires, and repeat the first step for the next speaker.
 - ④ Continue until you have isolated and replaced the shorted wire.
 - ⑤ See Chapter One of the *Connections and Setup Guide*.

If none of the above solutions work, reset the microprocessor:

1. Turn the receiver off.
2. Unplug the receiver.
3. Plug it back in while pressing and holding the Power switch (you may need someone else to help you do this)
 - The component set as input (Tuner is selected by default)—see “How Do I Operate Devices?” on page 36 of this manual.
 - The volume setting (-48dB is selected by default)—see “Adjusting the Volume” on page 10 of this manual
 - The tuner’s receiving band (FM is selected by default)— see “Radio Tuning” on page 44 of this manual
 - The tuner’s frequency (87.5MHz is selected by default)— see “Radio Tuning” on page 44 of this manual
 - The tuner’s preset memory—you will need to reset your stored radio stations (see “Presetting radio stations” on page 45 of this manual)
 - The surround setting—see “What are Listen Modes?” on page 18 of this manual
 - The speaker settings—you will need to reset your speaker settings (see Chapter Two of the *Connections and Setup Guide*)

Reset the cleared settings before operating the receiver again.

The sound is distorted, and the CLIP indicator on the receiver’s front panel flashes red continually, or stays red for more than 1 second at a time

Lower the analog input level for the source component you’re listening to. (Setting the proper input level eliminates distortion that occurs if a source component’s output level is too high. When this happens, the front panel CLIP indicator will flash red continually or remain red for periods of 1 second or longer. Occasional brief flashing of the CLIP indicator is okay). Adjust the analog input level for that component: See “Adjusting the Input level” on page 15 of this manual.

I can't receive a radio station

Check that:

- The appropriate antenna is connected. See Chapter One of the *Connections and Setup Guide*.
- The broadcast band is correct. See "Radio Tuning" on page 44 of this manual.
- The tuner is set to the correct frequency. See "Radio Tuning" on page 44 of this manual.

I'm getting a lot of static/interference

- Check whether the receiver or antenna is too close to a TV or other electrical appliance.
- Adjust the antenna for best reception.
- If you live in an area with weak FM signals, consider a rooftop FM antenna (available at any home electronics store).

When I press a button to tune to a preset station, the receiver does not respond

Check whether:

- The receiver has been unplugged for more than three days. If it has, your settings were cleared from the receiver's memory. See "My receiver won't turn on and the STANDBY indicator is flashing" on page 76 of this manual.
- The Tuner input is selected. See "Radio Tuning" on page 44 of this manual.

Numerics

200-Disc CD Changer	
operating	39
playing CDs	39
reading and storing disc titles ..	39

A

adjusting Remote Control unit display	50
analog input, switching	23
AV AUX front panel	3

B

balancing volume extremes	15
---------------------------------	----

C

CD player	
operating	39, 41
operating zone B	55
CD2/TAPE 2 MONITOR indicator	
light	3
CD-R recorder	
operating	41
changing front panel display	51
components	
operating	35
CONFIRM/SHIFT button	4, 8
custom macros	
executing	53
registering	52

D

Digital Signal Processor (DSP)	
effects	20
digital to analog recording	48
digital to digital recording	48
dimming receiver front panel	51
display screen	
adjusting	50
Dolby Digital	18
Dolby Pro Logic/Dolby Pro Logic II	18
D.R.I.V.E.	33
DTS	19
DTS-ES	19

DTS NEO:6	20
DVD player	
operating	38

H

headphones	
jack	3
using	34
home-theater sound	16

I

Input Analog mode	22
IR transmitters	7
items on Remote Control unit	4

L

laser disc player, operating	38
LCD display screen	6
listen modes	
Dolby Digital	18
Dolby Pro Logic/Dolby Pro	
Logic II	18
DSP	20
DTS	19
DTS-ES	19
DTS NEO:6	20
MPEG	20
Multi ch Music	20
setting manually	26
Stereo	20

M

macros	
executing	53
registering	52
MD recorder, operating	42
MPEG	20
Midnight Theatre function	16
Multi ch Music	20
mute button	5
muting sound	16
multiple zones	
operating devices	55
sound scenarios	54
switching control modes	54

O

- operating
 - devices 36
 - macros 53
 - range 7

P

- PHONO input 43
- Power indicator light 3
- Power On/Standby button 3
- preset stations 45

R

- radio stations 45
- reading and storing CD titles 39
- receiver
 - changing display mode 51
 - dimming front panel 51
 - items on front panel 3
- recording 47

S

- satellite TV, operating 37
- setting
 - Dolby Pro Logic II
 - parameters 29
 - DSP effects 31
 - input mode 23
 - listen mode manually 26
 - rec mode 48
 - THX mode 24
- sound
 - adjusting 9
 - tone, adjusting 11
- speakers
 - levels, adjusting 14
 - loudness, adjusting 13
 - selector buttons on receiver 9
- surround sound
 - listen modes 18
 - multiple zone 54
 - THX 17

switching

- to analog input 23
- zone control modes 54

T

- tape deck, operating 42
- THX 17
- THX surround EX 17
- tuner, operating 44
- turntable, operating 43
- TV, operating 37

U

- using
 - macros 53
 - Remote Control unit in the dark
 - 50

V

- VCR, operating 38
- volume
 - adjusting 10
 - control knob 3
 - down button 4
 - up button 4

Z

- zone
 - operating devices 55
 - sound scenarios 54
 - switching control modes 54